











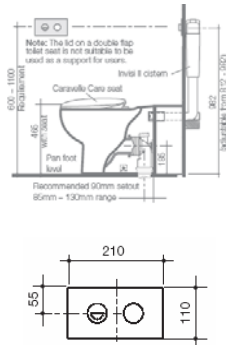

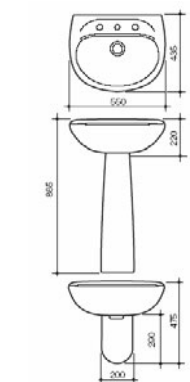

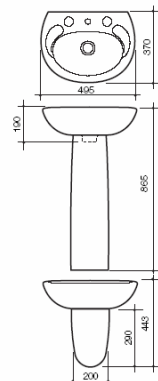

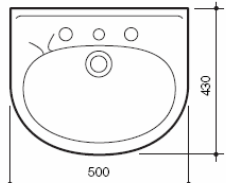
Education / Schools

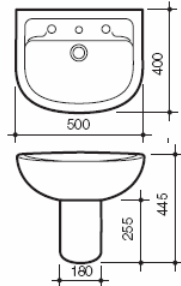



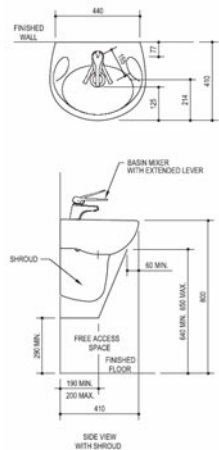

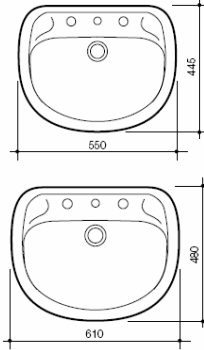

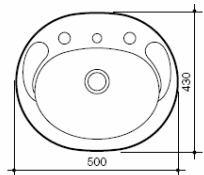

Sanitary & Tapware Product Suggestions
PERSONS WITH DISABILITY (PWD) FITTINGS

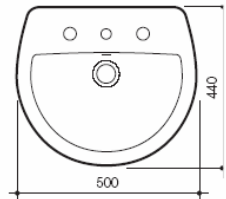
Category	Product Description	Features & Benefits	Image	Dimensions	WELS Rating	Code/s
Toilet Suite PWD BRONZE	CAROMA Cosmo Care Dual Flush Toilet Suite 	<ul style="list-style-type: none"> • 4.5/3 litre Dual Flush Suite: 4 Star WELS rated (S-trap only), 3 Star WELS rated (P-trap) • Vitreous China Pan (Cosmo Care Pan Concealed Trap) and Plastic Cistern (Cosmo Cistern) • Available as S or P Trap pan. Variable pan setout. • Supplied with raised White CAROMA Care plastic buttons and plastic cistern • Cistern plumbed from bottom left or right • Concealed trap to facilitate easy cleaning • Cosmo Care Suite supplied with Caravelle Care Seat – other seats will fit the pan • Economical Care Option 			4 3	S Trap 987918W P Trap 987928W (3 star WELS)
Toilet Suite PWD SILVER	CAROMA Cosmo Sovereign Care Suite 	<ul style="list-style-type: none"> • 4 Star WELS Rated (S trap only) • Integrated unit made up of the Sovereign cistern, featuring unique high profile flush buttons, and Cosmo concealed care pan • Care pan features side pan fixings, for increased stability during lateral transfers • Caravelle Care double flap seat included as standard • Chrome plated care buttons standard. • White care buttons Code: 416020 • Anti Vandal kit available: <ul style="list-style-type: none"> ▪ Round button code: 750109 ▪ Elongated button code: 800106 			4 3	S Trap 987916W P Trap 987926W (3 star WELS)



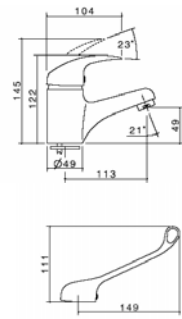

Category	Product Description	Features & Benefits	Image	Dimensions	WELS Rating	Code/s
Toilet Suite PWD SILVER	Caroma LEDA CARE INVISI II Suite 	<ul style="list-style-type: none"> • Suitable for S or P trap installations. Suitable for Induct/Inceiling installations where cistern can be serviced from the roof space or induct. • Suitable for inwall (min. 90mm wall cavity) and undercounter where cistern can be serviced from inside the room via access panel. • Features rough in and fit out kits • Pan: Leda Care back inlet • Seat: Caravelle Care Dbl flap • D80 fixing pack included • Buttons Sold Separately. <p>• <i>For compliance with AS1428-1 it is necessary to locally extend the wall out to provide the minimum pan projection of 800mm to the front of the pan.</i></p>	 		4	Induct, Inceiling, Inwall: 719100 + Care Buttons Chrome: 237011C Satin: 237011S
Wall Basin PWD SILVER	CAROMA Caravelle 550 	<ul style="list-style-type: none"> • Smooth rounded contours for easy cleaning • Generously sized basin with two soap holders • 10 litre capacity – NO overflow • Available with optional pedestal, shroud or bottle trap • Suitable for PWD use with shroud ONLY <p>Suitable tapware: Acqua Care; Nordic Care; Opus Care; Medica Prado Neu</p>			n/a	0TH 639000W; 1TH 639050W; 2TH 639020W; 3TH 639030W Shroud: 639950W Pedestal: 639900W



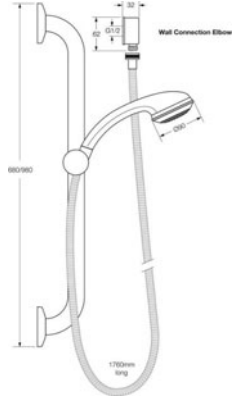

Category	Product Description	Features & Benefits	Image	Dimensions	WELS Rating	Code/s
Wall Basin PWD BRONZE	CAROMA Concorde 500 	<ul style="list-style-type: none"> • Space Saving Compact Size – smooth contours – easy cleaning • Two soap holders indentations • 5.5 litre capacity - NO Overflow • Available with optional pedestal, shroud or bottle trap • Suitable for PWD use with shroud ONLY <p>Suitable tapware: Acqua Care; Nordic Care; Opus Care</p>			n/a	1TH 631010W; 3TH 631030W Shroud: 639950W Pedestal: 639900W
Wall Basin PWD GOLD	CAROMA Integra 500 Wall Basin 	<ul style="list-style-type: none"> • Anti-splash rim • Hygienic and easy to clean trap • PWD approved • Chrome plated brass waste • Concealed integral trap • 10 litre capacity – NO overflow <p>Suitable tapware: Acqua Care; Nordic Care; Opus Care; Medica Prado Neu</p>			n/a	648210W
Wall Basin PWD SILVER	Caroma FLORA Wall Basin 	<ul style="list-style-type: none"> • Sleek design • Deep bowl • Anti-splash rim • Shroud & pedestal optional • Available in 1th, 3th, 0th • Overflow not available • Suitable for PWD use with shroud ONLY • Including fixing kit and coloured flush fitting uni plug and waste • Bowl capacity – 11 litres <p>Suitable tapware: Acqua Care; Nordic Care; Opus Care; Medica Prado Neu</p>	<i>(pictured with optional shroud)</i> 		n/a	0TH 641.200W 1TH 641210W 3TH 641230W Shroud: 651300W

Category	Product Description	Features & Benefits	Image	Dimensions	WELS Rating	Code/s
Wall Basin PWD SILVER	FOWLER Tasman Deluxe Wall Basin 	<ul style="list-style-type: none"> • Rounded, contemporary styling • Tear-drop soap recesses • Generous bowl size • 7 litre capacity • Optional shroud <p>Suitable tapware: Acqua Care; Nordic Care; Opus Care; Medica Prado Neu</p>			n/a	1 TH 814276W 3 TH 814234W Shroud: 814239W Pedestal: 814396W
Semi-Recessed Basin PWD SILVER	CAROMA Caravelle 550 & 600 	<ul style="list-style-type: none"> • Smooth rounded contours for easy cleaning • Generously sized basin with two soap holders • 550: 9 litre capacity – NO Overflow • 600: 14 litre capacity – NO Overflow <p>Suitable tapware: Acqua Care; Nordic Care; Opus Care; Medica Prado Neu</p>			n/a	550 0TH 659700W; 1TH 659710W; 3TH 659730W 600 0TH 659500W 1TH 659510W; 3TH 659530W
Semi-Recessed Basin PWD BRONZE	CAROMA Concorde 500 	<ul style="list-style-type: none"> • Compact, space saving – suitable for narrow countertops with a min. width of 300mm • 8 litre capacity – NO Overflow • Two soap holders <p>Suitable tapware: Acqua Care; Nordic Care; Opus Care</p>			n/a	1TH 654210W; 3TH 654230W

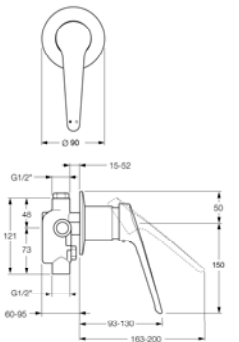
Category	Product Description	Features & Benefits	Image	Dimensions	WELS Rating	Code/s
Semi-Recessed Basin PWD BRONZE	CAROMA Cosmo 	<ul style="list-style-type: none"> • New Modern Compact Design • Overflow only • Bowl capacity 4 litres to overflow • Easy to clean – no sharp edges • Taphole options: 1TH (centre) or 3TH • Coloured plastic flush fitting Uni plug and waste supplied. <p>Suitable tapware: Acqua Care; Nordic Care; Opus Care; Medica Prado Neu</p>			n/a	1TH 864015W; 3TH 864035W
Basin Waste	CAROMA Plug & Waste	<ul style="list-style-type: none"> • 40mm • Anti-vandal • Chrome • Flush Fitting Uni Plug and Waste 		n/a	n/a	687141C
Basin Waste	CAROMA Plug & Waste	<ul style="list-style-type: none"> • 40mm • Anti-vandal • Chrome • Covered Uni Plug and Waste 		n/a	n/a	687143C
Basin Mixer PWD BRONZE	CAROMA Acqua Care Basin Mixer 	<ul style="list-style-type: none"> • 5 star WELS rated • Chrome finish • Ergonomic, easy to grip lever • Fixed outlet • Solid brass construction 			5	90987C5A + Lever 90997C
Basin Mixer PWD SILVER	CAROMA Nordic Care Basin Mixer 	<ul style="list-style-type: none"> • 5 Star WELS rated • Long life ceramic disc cartridge • Extended lever handle for those with restricted movement or care facilities • Pre-set temperature and flow settings to save energy and water • 5 Year warranty on Ceramic Disc Cartridge 			5	90965C5A

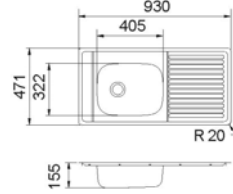
Category	Product Description	Features & Benefits	Image	Dimensions	WELS Rating	Code/s
Basin Mixer PWD SILVER	CAROMA Opus Care Basin Mixer 	<ul style="list-style-type: none"> • 5 Star WELS rated • Long life ceramic disc cartridge • Extended lever handle for those with restricted movement or care facilities • Pre-set temperature and flow settings to save energy and water • Long life, soft close cartridge reduces noisy water hammer • Ergonomic, easy grip handle • 5 Year warranty on Ceramic Disc Cartridge 			5	87144C5A + Lever 90921C
Basin Mixer PWD SILVER	HANSA Medica Prado Neu Basin Mixer with extended lever 	<ul style="list-style-type: none"> • 6 or 4 star WELS rated • Lever suitable for disabled use • Patented grease wells within cartridge • Adjustable hot water stop provides additional anti-scald capability cartridge • Warranty - 5 year parts and labour; 15 year parts on cartridge 			6 4	6★ 014222460037 4★ 014222760037

Category	Product Description	Features & Benefits	Image	Dimensions	WELS Rating	Code/s
Shower PWD BRONZE	VIRTU Plus Starsafe Shower Set – Ecojet Neu 	<ul style="list-style-type: none"> • Includes grab rail with durable adjustable slider, hand shower, flexi hose and wall elbow connection. • 3 star WELS rated • Grab rail - 304 brushed stainless steel • Includes wall elbow and non-return valve • Meets AS1428.1 requirements • 5 year warranty 			3	S/SAFE/C19
Shower Mixer PWD SILVER	HANSA Medica Piccolo Shower Mixer 	<ul style="list-style-type: none"> • Features HANSA ECO Control Cartridge • Warranty - 5 year parts and labour; 15 year parts on cartridge 			n/a	'01470176

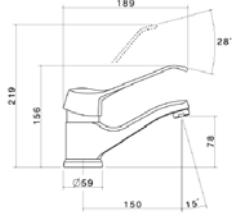
Category	Product Description	Features & Benefits	Image	Dimensions	WELS Rating	Code/s
Sink BRONZE	CLARK Benchmark 930mm Single End Bowl Sink	<ul style="list-style-type: none"> No-nonsense design Shallow bowl may be suitable for PWD use Bowl Volume 13.5l Easy to clean stainless steel Available in left (1003) or right (1004) hand bowl configuration Available with 0, 1 or 3 tapholes Sleek and stylish 25yr warranty NB: May be suitable for PWD use with Heat Protection Pad Code A0152 			n/a	1003 (OTH LHB), 1003.3 (3TH LHB), 1004 (OTH RHB), 1004.3 (3TH RHB) Heat Protection Pads - fitted to underside of Sink – A0152
Sink Mixer PWD SILVER	CAROMA Nordic Care Sink Mixer 150mm 	<ul style="list-style-type: none"> 4 Star WELS rated Long life ceramic disc cartridge Extended lever handle for those with restricted movement or care facilities Pre-set temperature and flow settings to save energy and water 5 Year warranty on Ceramic Disc Cartridge 	 		4	90966C4A

For CAD and technical downloads, visit:
(note CAD not available for tapware)

www.caroma.com.au
www.clark.com.au
www.dorf.com.au
www.fowler.com.au
www.hansataps.com
www.irwell.com.au
www.radiantstainless.com.au
www.starion-industries.com
www.stylus.com.au

To help you work within your budgets and planning, we have categorised each of the products:

BRONZE = Products that would be considered entry level

SILVER = Products that would be considered mid range

GOLD = Products that would be considered high range

These symbols should be used **as a guide only** as it is almost impossible to compare different products based on price alone. We have tried to take into account many different elements of the product including features, quality, cost of installation, and price. As our range across all brands is so large we have not been able to include every product, however we have included those specified most often. Please call Caroma Dorf on 07 3131 5999 or 1800 227 662 if you would like specific pricing or technical details. Final pricing is heavily dependent on quantities.